

## Installation Instructions

### PARTS LIST

Hood protector



Adhesive pedestals (2)

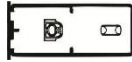

Clip bodies (4)  
Corps de pince (4)



Pins (6)



Screws (6)



Anti-abrasion pads- large (4)



Anti-abrasion pads- small (2)



Metal mounting brackets (2)



Metal "L" brackets (4)



Surface cleaner (1)



Re-useable tape strips (1)

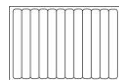

### TOOLS AND SUPPLIES REQUIRED

Long shank Phillips screwdriver #2

Tape measure

Masking tape

### INSTALLATION

- Ensure the vehicle is clean and completely dry before installation.



- This product uses a 3M adhesive that requires installation and curing temperatures of 15° to 43°C (60° to 110°F) for 1 hr. to develop maximum adhesion to the hood surface. Failure to install this product at the proper temperature or allow adequate curing time before use is not covered under warranty.



- Proper installation of the adhesive pedestal system requires the use of a #2 Phillips screwdriver, preferably with a long shaft. The shaft of the screwdriver needs to fit through the hole in the pedestal. Use of the correct screwdriver will facilitate a trouble free installation. Do not attempt to use #1 or smaller Phillips screwdriver or any type of powered screwdriver.

### CARE

Hand clean the protector using a mild soap and water solution or plastic cleaner only.

Avoid automatic car-wash equipment where a brush and/or soft cloth come in contact with the hood protector. Touch-less style automatic car-wash equipment is less likely to harm the air protector.

### Service

Periodically check to confirm the protector is securely attached to the hood.

### WARNINGS

Do not pull/push on the protector when opening/ closing the hood.

1. Dry fit an adhesive pedestal using the re-usable tape strips or masking tape to hold it in position. The position is shown in the **illustration**. Use the center mark on the leading edge of the pedestal for accurate measuring. The fingers on the leading edge of the pedestal will help ensure the correct position relative to the hood edge. When correctly positioned the fingers should contact the leading edge of the hood.

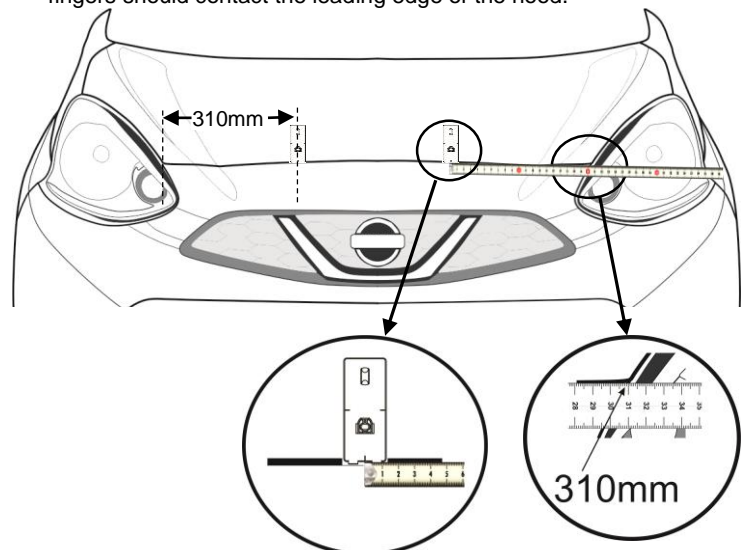

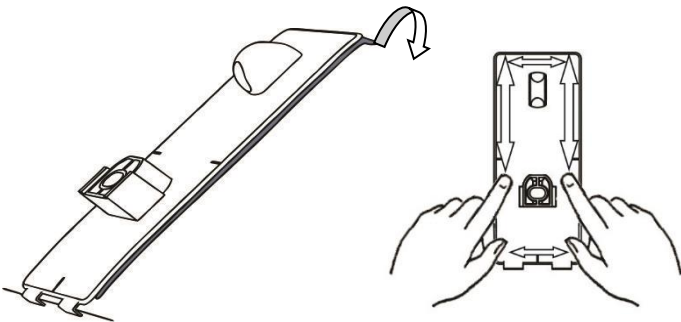
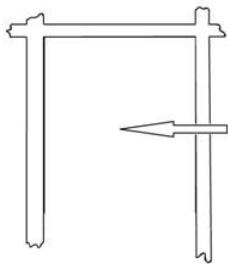
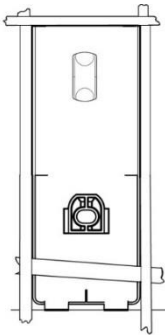
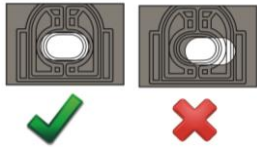
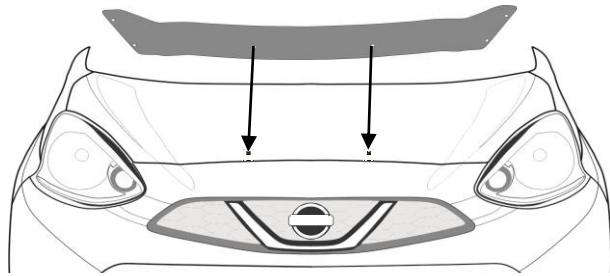

2. Repeat for the pedestal on the other side.

*Répétez l'opération pour le pied de l'autre côté.*

3. Place the hood protector on the pedestals to confirm proper positioning. Ensure the holes in the protector align with those in the pedestals. If necessary, reposition the pedestals so all attachment positions are correct and the protector is well centered.

4. Remove the hood protector, and outline the perimeter of the pedestals with the re-usable tape strips supplied or masking tape. As shown in the illustration.

5. Remove the pedestals and thoroughly clean the outlined area with the automotive surface cleaner. Wipe dry with a clean cloth or paper towel. This will insure all wax, finger prints and oils are removed from the hood surface in the bonding area.



**Important! Proper preparation of the hood surface will ensure maximum adhesive bond.**

6. One pedestal at a time, remove the protective backing from the adhesive and install on the hood surface.

**Use caution to not contaminate the adhesive surface**  
**Faites attention de ne pas contaminer la surface adhésive**

**Tip:** Hook the fingers on the pedestal over the hood edge and rotate the unit into position. After installation, remove the re-usable tape strips or masking tape and “wet out” the adhesive to the hood surface by applying pressure with your thumb around the complete surface of the pedestals.



**Important:** “wetting out” of the pedestals will ensure maximum adhesive bond.

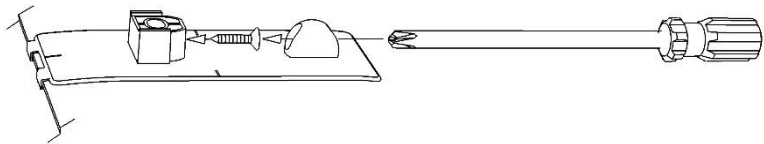

7. Start a screw into each pedestal a few turns. The tip of the screw must not protrude into the hole where the attachment pin will install later.

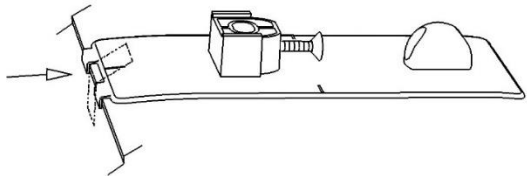

8. Peel and fold the two (2) small anti abrasion film pad in half over the hood edge between the fingers on each of the pedestals.

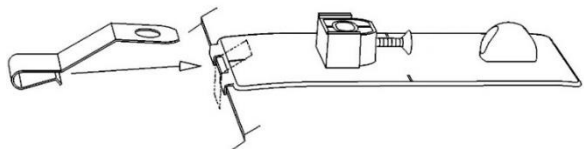

9. Push a metal mounting bracket over the hood edge on top of the anti-abrasion pad installed previously. Ensure the bracket is fully engaged over the hood edge and the hole in the bracket is aligned with the hole in each of the pedestals.

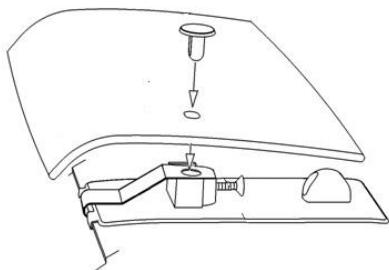

10. Place the protector on the pedestals and, install a pin through the protector and into each of the pedestals.

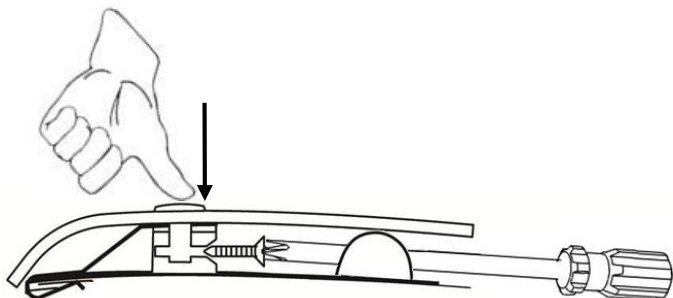

11. Maintain slight pressure on the pin, to ensure proper seating of the components, while simultaneously tightening the screw on all of the adhesive pedestals.



**NOTE: Only tighten screw a few turns so that the pin is held in but there is some movement of the protector. This helps with the installation of the components above the headlights.**

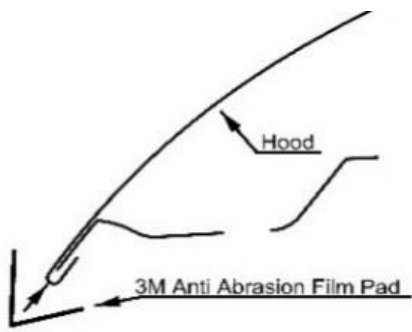

12. Peel and fold the four (4) large anti-abrasion film pads in half over the hood edge aligned with the outer holes of the protector in the area above the headlights.

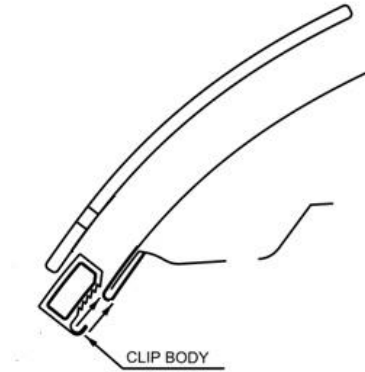

13. Place a clip body over each of the anti-abrasion film pads on the edge of the hood.

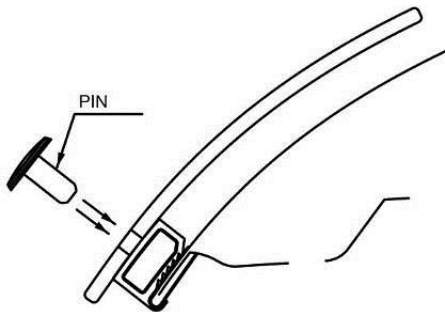

14. Insert a pin through the protector into each of the clip bodies.

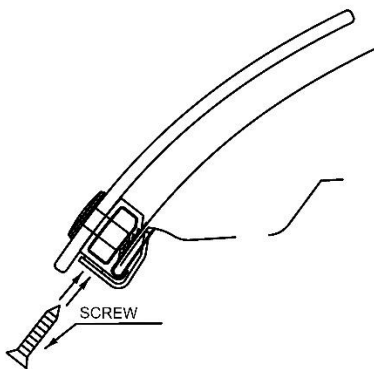

15. Insert a screw through an 'L'- bracket and into the clip body.
16. Make sure all the components are well seated together and then tighten the screws into the clip bodies.
17. Tighten the three screws into the pedestals from step#11

**NOTE: To allow the adhesive to cure do not wash the vehicle for 24 hrs. Please inform the customer of this.**